

### MIXER AMPLIFIERS

**BG-2035**  
**BG-2060**  
**BG-2120**

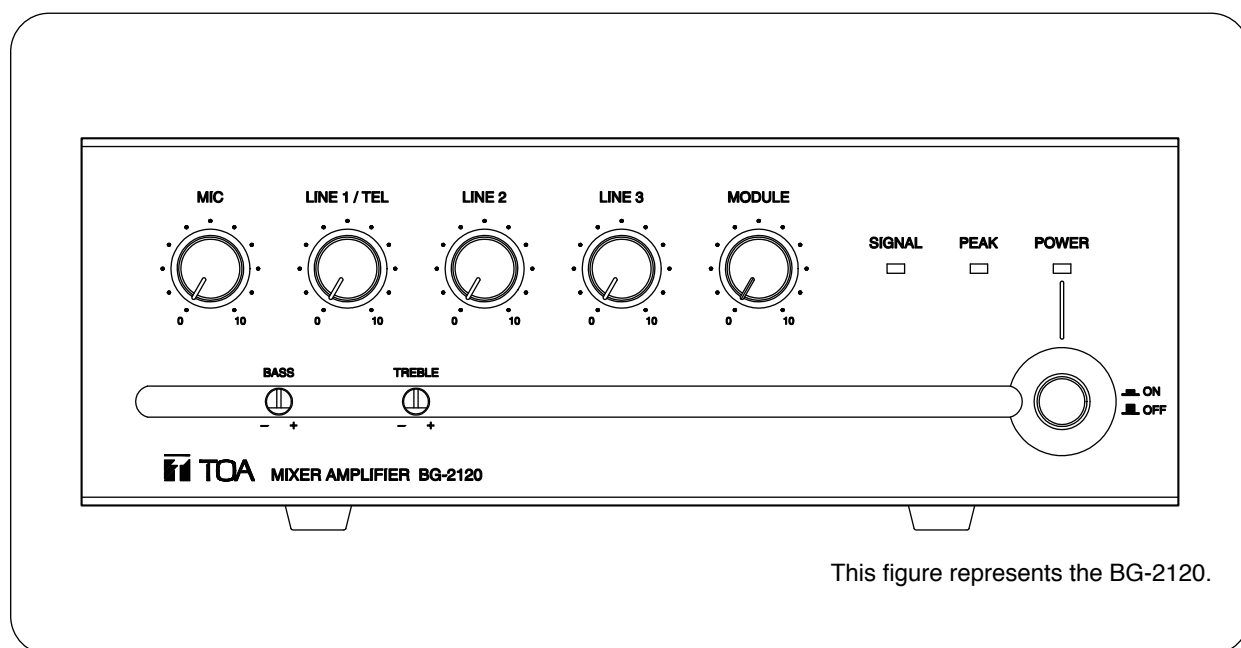

### TABLE OF CONTENTS

<b>1. IMPORTANT SAFETY INSTRUCTIONS</b> ....	2	7.2. Automatic Mute .....	13
<b>2. SAFETY PRECAUTIONS</b> .....	3	<b>8. MOH OUTPUT ASSIGNMENT</b> .....	13
<b>3. GENERAL DESCRIPTION</b> .....	5	<b>9. 2-CHANNEL BROADCAST</b> .....	14
<b>4. FEATURES</b> .....	5	<b>10. OPERATION</b> .....	15
<b>5. NOMENCLATURE AND FUNCTIONS</b>		<b>11. INSTALLATION PRECAUTIONS</b> .....	15
Front .....	6	<b>12. RACK MOUNTING BRACKET</b>	
Rear .....	7	<b>ATTACHMENT</b> .....	15
<b>6. CONNECTIONS</b>		<b>13. VOLUME SETTING</b> .....	16
6.1. Removable Terminal Plug		<b>14. VOLUME CONTROL COVER</b> .....	16
Connection .....	9	<b>15. BLOCK DIAGRAM</b> .....	17
6.2. Input Connections .....	9	<b>16. DIMENSIONAL DIAGRAM</b> .....	18
6.3. Plug-In Module Input Connection .....	10	<b>17. SPECIFICATIONS</b> .....	19
6.4. Output Connections .....	10	Accessories .....	20
6.5. Manual Mute Terminal Connection ....	11	Optional Product .....	20
6.6. Remote Volume Control Connection ..	11		
<b>7. MUTING FUNCTION</b>			
7.1. Manual Mute .....	12		

Thank you for purchasing TOA's Mixer Amplifier.

Please carefully follow the instructions in this manual to ensure long, trouble-free use of your equipment.

# 1. IMPORTANT SAFETY INSTRUCTIONS

- Read these instructions.
- Keep these instructions.
- Heed all warnings.
- Follow all instructions.
- Do not use this apparatus near water.
- Clean only with dry cloth.
- Do not block any ventilation openings. Install in accordance with the manufacturer's instructions.
- Do not install near any heat sources such as radiators, heat registers, stoves, or other apparatus (including amplifiers) that produce heat.
- Do not defeat the safety purpose of the polarized or grounding-type plug. A polarized plug has two blades with one wider than the other. A grounding type plug has two blades and a third grounding prong. The wide blade or the third prong are provided for your safety. If the provided plug does not fit into your outlet, consult an electrician for replacement of the obsolete outlet.
- Protect the power cord from being walked on or pinched particularly at plugs, convenience receptacles, and the point where they exit from the apparatus.
- Only use attachments/accessories specified by the manufacturer.
- Use only with the cart, stand, tripod, bracket, or table specified by the manufacturer, or sold with the apparatus. When a cart is used, use caution when moving the cart/apparatus combination to avoid injury from tip-over.



- Unplug this apparatus during lightning storms or when unused for long periods of time.
- Refer all servicing to qualified service personnel. Servicing is required when the apparatus has been damaged in any way, such as power-supply cord or plug is damaged, liquid has been spilled or objects have fallen into the apparatus, the apparatus has been exposed to rain or moisture, does not operate normally, or has been dropped.

## INSTRUCTIONS ESSENTIELLES POUR LA SÉCURITÉ

- Lire ces instructions.
- Conserver ces instructions pour référence ultérieure.
- Respecter tous les avertissements.
- Suivre toutes les instructions.
- Ne pas utiliser cet appareil à proximité d'eau.
- Nettoyer uniquement à l'aide d'un chiffon sec.
- Ne pas obstruer les orifices de ventilation. Installer conformément aux instructions du fabricant.
- Ne pas installer à proximité de sources de chaleur telles que des radiateurs, des registres thermiques, des chaudières ou d'autres appareils (notamment des amplificateurs) produisant de la chaleur.
- Ne pas contourner la fonction de sécurité de la fiche polarisée ou de mise à la terre. Une fiche polarisée est équipée de deux broches, dont l'une est plus large que l'autre. Une fiche de mise à la terre est équipée de deux broches et d'une troisième pour la mise à la terre. Cette dernière, la plus large, est prévue à des fins de sécurité. Si la fiche fournie ne peut être insérée dans la prise électrique souhaitée, consulter un électricien pour faire remplacer cette dernière.
- Protéger le cordon d'alimentation pour éviter qu'il ne soit piétiné ou pincé, notamment au niveau des fiches, des prises de courant ou de son point de sortie de l'appareil.
- Utiliser uniquement les accessoires spécifiés par le fabricant.
- Utiliser uniquement avec le chariot, support, trépied, la patte de montage ou la table spécifiés par le fabricant ou vendus avec l'appareil. En cas d'utilisation d'un chariot, manipuler la combinaison chariot/appareil pour éviter les blessures dues à un renversement.



- Débrancher cet appareil pendant les orages ainsi que lorsqu'il reste inutilisé pendant une période prolongée.
- La maintenance de l'appareil doit être confiée à un technicien après-vente qualifié. Une maintenance s'avère nécessaire si l'appareil est endommagé (au niveau du cordon d'alimentation ou de la fiche), a été mouillé par un liquide, un objet est tombé à l'intérieur, s'il a été exposé à la pluie ou l'humidité, s'il ne fonctionne pas normalement ou s'il est tombé.

## 2. SAFETY PRECAUTIONS

- Before installation or use, be sure to carefully read all the instructions in this section for correct and safe operation.
- Be sure to follow all the precautionary instructions in this section, which contain important warnings and/or cautions regarding safety.
- After reading, keep this manual handy for future reference.

### Safety Symbol and Message Conventions

Safety symbols and messages described below are used in this manual to prevent bodily injury and property damage which could result from mishandling. Before operating your product, read this manual first and understand the safety symbols and messages so you are thoroughly aware of the potential safety hazards.



The exclamation point within an equilateral triangle is intended to alert the user to the presence of important operation and maintenance (servicing) instruction in the literature accompanying the appliance.



Le point d'exclamation à l'intérieur d'un triangle équilatéral avertit l'utilisateur de l'existence d'instructions d'utilisation et d'entretien (réparation) dans la documentation fournie avec l'appareil.



### **WARNING**

Indicates a potentially hazardous situation which, if mishandled, could result in death or serious personal injury.

#### When Installing the Unit

- Do not expose the unit to rain or an environment where it may be splashed by water or other liquids, as doing so may result in fire or electric shock.
- Use the unit only with the voltage specified on the unit. Using a voltage higher than that which is specified may result in fire or electric shock.
- Do not cut, kink, otherwise damage nor modify the power supply cord. In addition, avoid using the power cord in close proximity to heaters, and never place heavy objects -- including the unit itself -- on the power cord, as doing so may result in fire or electric shock.
- Avoid installing or mounting the unit in unstable locations, such as on a rickety table or a slanted surface. Doing so may result in the unit falling down and causing personal injury and/or property damage.
- External wiring connected to the terminals marked with ⚡ requires installation by an instructed person.
- The apparatus shall be connected to a mains socket outlet with a protective earthing connection.
- L'appareil doit être branché à une prise d'alimentation avec mise à la terre de protection.
- The socket-outlet shall be installed near the equipment and the plug (disconnecting device) shall be easily accessible.
- Use the optional Rack mounting bracket MB-1000 when mounting the unit(s) in an equipment rack. Remove four M4 x 8 screws on both sides of the unit, and mount the bracket there using the M4 x 16 screws (supplied with the bracket) instead.

#### When the Unit is in Use

- Should the following irregularity be found during use, immediately switch off the power, disconnect the power supply plug from the AC outlet and contact your nearest TOA dealer. Make no further attempt to operate the unit in this condition as this may cause fire or electric shock.
  - If you detect smoke or a strange smell coming from the unit
  - If water or any metallic object gets into the unit
  - If the unit falls, or the unit case breaks
  - If the power supply cord is damaged (exposure of the core, disconnection, etc.)
  - If it is malfunctioning (no tone sounds.)
- To prevent a fire or electric shock, never open nor remove the unit case as there are high voltage components inside the unit. Refer all servicing to your nearest TOA dealer.
- Do not place cups, bowls, or other containers of liquid or metallic objects on top of the unit. If they accidentally spill into the unit, this may cause a fire or electric shock.
- Do not insert nor drop metallic objects or flammable materials in the ventilation slots of the unit's cover, as this may result in fire or electric shock.



## CAUTION

Indicates a potentially hazardous situation which, if mishandled, could result in moderate or minor personal injury, and/or property damage.

### When Installing the Unit

- Never plug in nor remove the power supply plug with wet hands, as doing so may cause electric shock.
- When unplugging the power supply cord, be sure to grasp the power supply plug; never pull on the cord itself. Operating the unit with a damaged power supply cord may cause a fire or electric shock.
- When moving the unit, be sure to remove its power supply cord from the wall outlet. Moving the unit with the power cord connected to the outlet may cause damage to the power cord, resulting in fire or electric shock. When removing the power cord, be sure to hold its plug to pull.
- Do not block the ventilation slots in the unit's cover. Doing so may cause heat to build up inside the unit and result in fire.
- Avoid installing the unit in humid or dusty locations, in locations exposed to the direct sunlight, near the heaters, or in locations generating sooty smoke or steam as doing otherwise may result in fire or electric shock.
- To avoid electric shocks, be sure to unplug the unit's power supply cord when connecting speakers.
- Be sure to follow the instructions below when rack-mounting the unit. Failure to do so may cause a fire or personal injury.
  - Install the equipment rack on a stable, hard floor. Fix it with anchor bolts or take other arrangements to prevent it from falling down.
  - When connecting the unit's power cord to an AC outlet, use the AC outlet with current capacity allowable to the unit.
  - No rack-mounting screws are supplied with the unit. Separately prepare the appropriate screws for the rack.
- Keep the amplifier over 10 cm (3.94") away from objects that may obstruct air flow to prevent the unit's internal temperature rise.

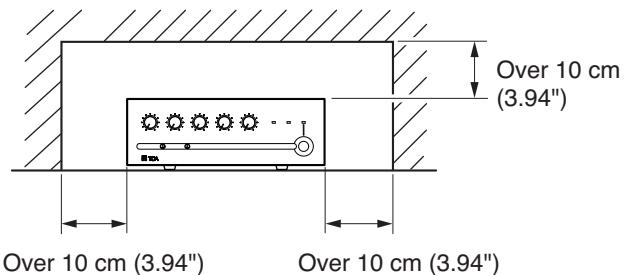

### When the Unit is in Use

- Do not place heavy objects on the unit as this may cause it to fall or break which may result in personal injury and/or property damage. In addition, the object itself may fall off and cause injury and/or damage.
- Make sure that the volume control is set to minimum position before power is switched on. Loud noise produced at high volume when power is switched on can impair hearing.
- Do not operate the unit for an extended period of time with the sound distorting. This is an indication of a malfunction, which in turn can cause heat to generate and result in a fire.
- If dust accumulates on the power supply plug or in the wall AC outlet, a fire may result. Clean it periodically. In addition, insert the plug in the wall outlet securely.
- Switch off the power, and unplug the power supply plug from the AC outlet for safety purposes when cleaning or leaving the unit unused for 10 days or more. Doing otherwise may cause a fire or electric shock.



The lightning flash with arrowhead symbol, within an equilateral triangle, is intended to alert the user to the presence of uninsulated "dangerous voltage" within the product's enclosure that may be of sufficient magnitude to constitute a risk of electric shock to persons.



L'éclair accompagné d'un symbole représentant une pointe de flèche à l'intérieur d'un triangle équilatéral avertit l'utilisateur de la présence d'une "tension dangereuse" à l'intérieur de l'enceinte du téléviseur, dont la magnitude peut être suffisante pour constituer un risque de choc électrique pour les personnes.

## **ATTENTION**

L'appareil ne doit pas être exposé aux éclaboussures ou écoulements et tous objets remplis de liquide, tels que vases, ne doivent pas être sur l'appareil.

### **3. GENERAL DESCRIPTION**

The BG-2035 (35 W), BG-2060 (60 W), and BG-2120 (120 W) are 5-input mixer amplifiers for background music and general announcement. These units are suited for use in bars, retail stores, and banquet rooms, and are equipped with the MOH output that permits 2-channel broadcast when used in conjunction with the optional booster amplifier BA-235 (35 W) or BA-260 (60 W).

### **4. FEATURES**

- Each input freely assignable to the MOH output.
- Automatic or manual mute function.
- Easy setting of each function with the rear-mounted DIP switches.  
(Each input to MOH output assignment settings, Mute settings, LINE 1/TEL level settings, and Phantom power ON/OFF setting)
- Supplied volume control covers prevent accidental operation of input knobs.
- Front operable bass and treble controls.  
Also front panel recessed knobs help to prevent accidental operation.
- Removable input/output terminal blocks facilitate installation and maintenance.  
Besides, RCA jacks provided for Lines 2 and 3.
- External remote volume control for speaker output level adjustment.

## 5. NOMENCLATURE AND FUNCTIONS

[Front]

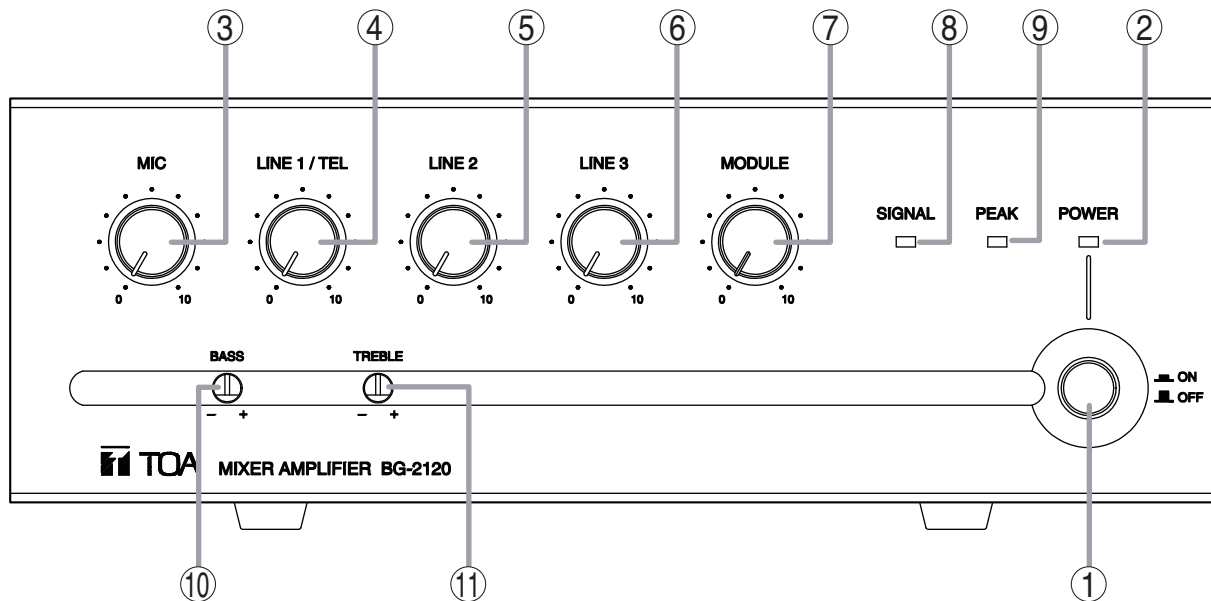

This figure represents the BG-2120.

### 1. Power switch

Power is switched on and off with each depression of this switch.

### 2. Power indicator

Lights blue when the Power switch (1) is switched on.

### 3. Microphone input volume control

Adjusts gain of the microphone input. Turn the knob clockwise to increase the volume and counterclockwise to decrease it.

#### Note

This control is not active for the MOH output terminal (26).

### 4. Line 1/TEL input volume control

Adjusts gain of the Line 1 or TEL input. Turn the knob clockwise to increase the volume and counterclockwise to decrease it. Refer to the Function switch (24) on the next page to switch between Line 1 or TEL.

#### Note

This control is not active for the MOH output terminal (26).

### 5. Line 2 input volume control

Adjusts gain of the Line 2 input. Turn the knob clockwise to increase the volume and counterclockwise to decrease it.

#### Note

This control is not active for the MOH output terminal (26).

### 6. Line 3 input volume control

Adjusts gain of the Line 3 input. Turn the knob clockwise to increase the volume and counterclockwise to decrease it.

#### Note

This control is not active for the MOH output terminal (26).

### 7. Module input volume control

Adjusts gain of the Module input. Turn the knob clockwise to increase the volume and counterclockwise to decrease it.

#### Note

This control is not active for the MOH output terminal (26).

### 8. Signal level indicator

Lights green when audio signals are output from the speaker output terminal.

### 9. Peak indicator

Lights red if output signals approach clipping level. If steady lit, turn down the corresponding input volume control until the indicator flashes intermittently.

### 10. Bass control

Turn the knob clockwise to increase bass level and counterclockwise to decrease it. The center position of the control provides flat frequency response.

### 11. Treble control

Turn the knob clockwise to increase treble level and counterclockwise to decrease it. The center position of the control provides flat frequency response.

[Rear]

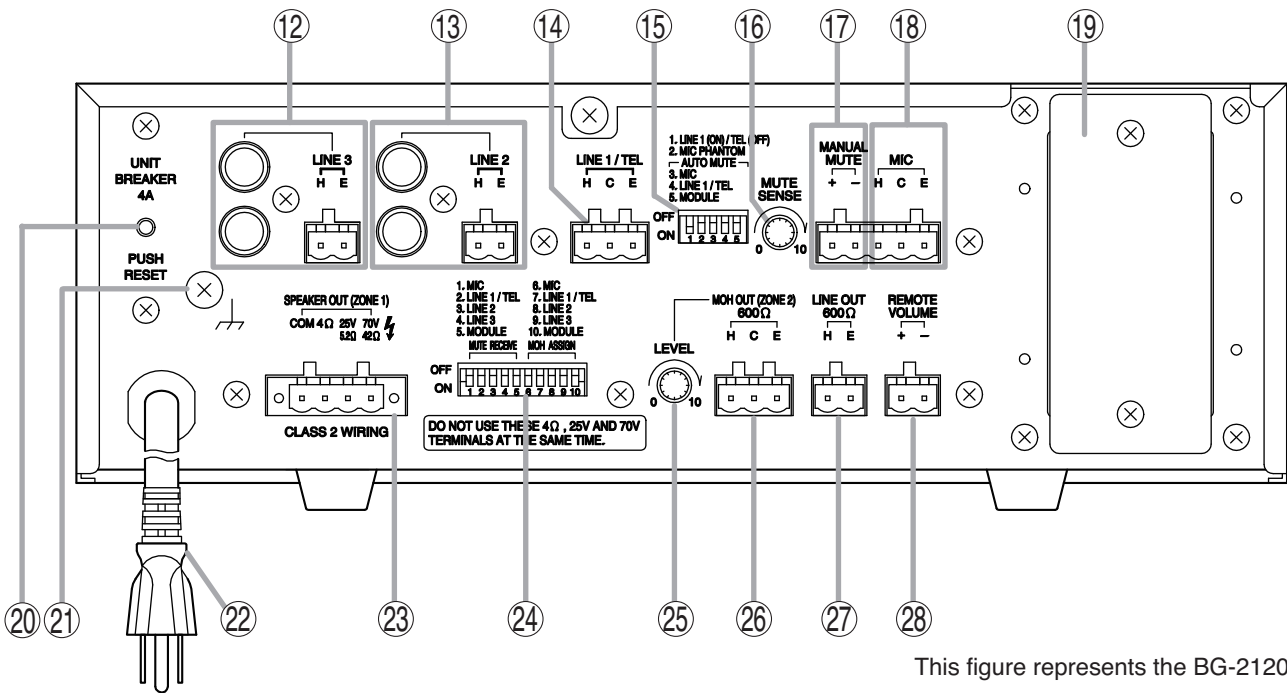

This figure represents the BG-2120.

**12. Line 3 input terminals**

10 kΩ, -10 dB\*, unbalanced, removable terminal block and RCA jacks. (Upper and lower RCA jacks are internally, passively mixed.) Connect a sound source equipment such as a CD player.

**13. Line 2 input terminals**

10 kΩ, -10 dB\*, unbalanced, removable terminal block and RCA jacks. (Upper and lower RCA jacks are internally, passively mixed.) Connect a sound source equipment such as a CD player.

**14. Line 1/TEL input terminal**

10 kΩ, -10 dB\* (LINE 1)/-20 dB\* (TEL) Electronically-balanced, removable terminal block. Use the Function switch A (15) to select either Line 1 or TEL. Connect a telephone or a sound source equipment.

**15. Function switch A**

Used for LINE 1/TEL gain switching, phantom power ON/OFF settings, and Mute Send mode settings.

• **DIP switch 1**

- ON: Switches the LINE 1/TEL input gain to LINE 1 (-10 dB).
- OFF: Switches the LINE 1/TEL input gain to TEL (-20 dB).

• **DIP switch 2**

- Sets ON or OFF depending on whether or not the microphone connected to the MIC input requires phantom power.
- ON: Supplies phantom power (24 V DC) to the microphone.
- OFF: Turns off the phantom power supply.

• **DIP switch 3**

Set to ON to place the MIC input in Mute Send mode (audio signal-activated muting mode).

• **DIP switch 4**

Set to ON to place the LINE 1 or TEL input in Mute Send mode (audio signal-activated muting mode).

• **DIP switch 5**

Set to ON to place the MODULE input in Mute Send mode (audio signal-activated muting mode).

**Notes**

- Switch 1 is set to the ON position by default.
- Switches 2 – 5 are set to the OFF position by default.
- Be sure to turn off the power before performing above settings. Failure to do so may cause the loud noise to be generated or unit failure.

**16. Mute sensitivity control**

Adjusts the threshold level for the MIC, LINE 1/TEL, and MODULE inputs to activate the mute function. Turn clockwise to increase the threshold level (lower sensitivity), and counterclockwise to decrease it (higher sensitivity).

**Note**

The audio signal level to activate muting is independent of input volume settings. So, the Mute Receive input is muted if a signal enters the MIC, LINE 1/TEL, or MODULE input even when the input volume is turned down. To avoid unwanted muting caused by unintentional inputs such as background noise and noise sound, it is recommended to cut the audio signal at the input equipment (such as a microphone with talk switch).

\* 0 dB = 1 V

### 17. Manual Mute terminals

Closing between (+) and (–) terminals mutes the input signal set for Mute Receive by the Function switch B (24).

Opening between (+) and (–) terminals returns the previously muted signal gradually to its original level.

#### Notes

- This function is active regardless of the Automatic mute ON/OFF settings using the Function switch A (15).
- This function is not active for the MOH output terminal.

### 18. Microphone input terminal

600  $\Omega$ , –60 dB\*, electronically-balanced, removable terminal block.

Connect a microphone.

### 19. Module input port

Accepts one of 900 series plug-in modules. For the selection of the most appropriate module, refer to Plug-in Module instruction manual.

### 20. Breaker

Cuts off the AC power supply from the AC outlet if the power current exceeds the allowable value.

#### Note

The yellow button in the breaker pops out to indicate that the breaker has tripped. After turning off the power and eliminating the cause of the breaker trip, press the button to reset the breaker.

### 21. Functional ground terminal

Hum noise may be generated when external equipment is connected to the unit. Connecting this terminal to the functional ground may reduce the hum noise.

#### Note

This terminal is not for protective earth.

### 22. AC power cord

Connect this cord to an AC wall outlet.

### 23. Speaker output terminal

4  $\Omega$ , 25 V and 70 V outputs, removable terminal block.

Connects to speakers. Refer to p.10

### 24. Function switches B

Used for MOH Assignment and Mute Receive function settings.

- **DIP switch 1**  
Set to ON to place the MIC input in MUTE Receive mode.
- **DIP switch 2**  
Set to ON to place the LINE 1/TEL input in Mute Receive mode.
- **DIP switch 3**  
Set to ON to place the LINE 2 input in Mute Receive mode.

- **DIP switch 4**

Set to ON to place the LINE 3 input in Mute Receive mode.

- **DIP switch 5**

Set to ON to place the MODULE input in Mute Receive mode.

- **DIP switch 6**

Set to ON to output the MIC input to the MOH output.

- **DIP switch 7**

Set to ON to output the LINE 1/TEL input to the MOH output.

- **DIP switch 8**

Set to ON to output the LINE 2 input to the MOH output.

- **DIP switch 9**

Set to ON to output the LINE 3 input to the MOH output.

- **DIP switch 10**

Set to ON to output the MODULE input to the MOH output.

#### Notes

- Switches 1 – 10 are set to the OFF position by default.
- Be sure to turn off the power before performing above settings. Failure to do so may cause the loud noise to be generated or unit failure.

### 25. MOH volume control

Adjusts the gain of the MOH output level (26)

### 26. MOH output terminal

600  $\Omega$ , 0 dB\*, transformer-isolated, removable terminal block.

By connecting the input terminal of the BA-235 or BA-260, 2-channel broadcast can be made.

Refer to p.11.

**Note:** Bass and treble controls are not active for this output.

### 27. Line output terminal

600  $\Omega$ , 0 dB\*, unbalanced, removable terminal block.

**Note:** Bass and treble controls are not active for this output.

### 28. Remote volume terminal

Removable terminal block.

Connecting a 10 k $\Omega$  linear taper volume control across these terminals will allow remote control of speaker output level.

\* 0 dB = 1 V



## 6. CONNECTIONS

### 6.1. Removable Terminal Plug Connection

#### Notes

- Avoid soldering cable conductor, as contact resistance may increase when the cable is tightened and the solder is crushed, possibly resulting in an excessive rise in joint temperatures.
- Use cables of AWG 12 – 24.

#### [Cable end treatment]

2-core shielded cable

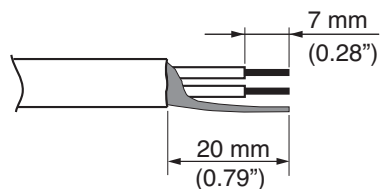

Solid cable and stranded cable

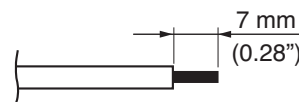

#### [Wiring Procedure]

##### Step 1. Wiring the supplied removable terminal plug.

- 1-1. Loosen the terminal screws to insert the wire.
- 1-2. Tighten the terminal screws.  
Ensure that the wire does not break free when pulled. If the wire does pull free, repeat the connection procedure from the start.

##### Step 2. Insert the wired terminal plug into the corresponding terminal block in the unit's rear panel.

##### Step 3. Tighten the fixing screws. (Speaker output terminals only)

#### Notes

- Do not reverse **Steps 1** and **2**. Poor contact may result if force is applied to the unit's internal circuit board pins while the terminal screws are being tightened.
- Use an appropriate type screwdriver for terminal plug wiring.

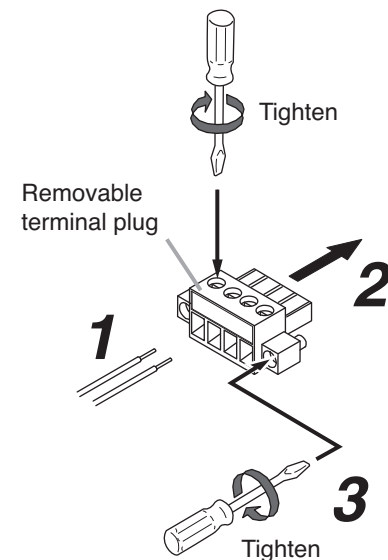

## 6.2. Input Connections

### 6.2.1. MIC input connections

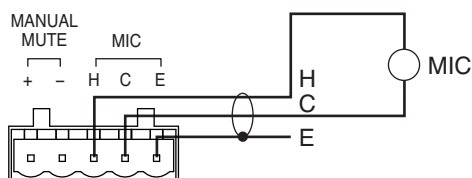

### 6.2.2. LINE 1/TEL input connections

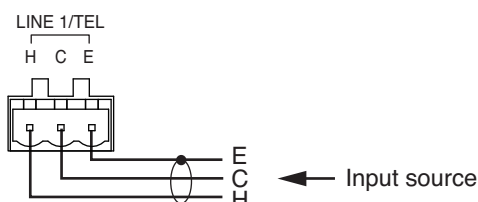

### 6.2.3. LINE 2, LINE 3 input connections

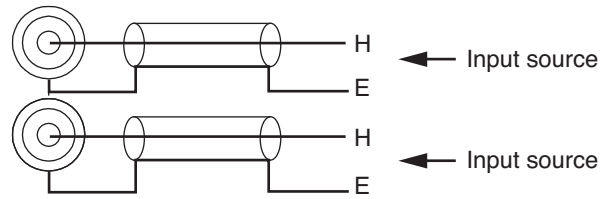
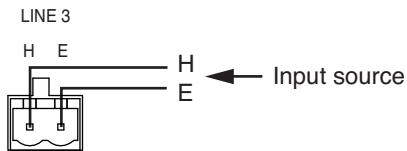

Upper and lower RCA jacks are internally, passively mixed.

### 6.3. Plug-In Module Input Connection

A single port for TOA plug-in modules is located on the unit's rear panel. Any 900 Series plug-in module can be inserted into this port.

#### Notes

- Consult your nearest TOA dealer for selection of appropriate module types.
- Be sure to turn off the power before installing the module.

#### [Installation]

**Step 1.** Remove the blank panel covering the module slot on the rear panel.

**Step 2.** Align the module board with the top and bottom guide rails, and press in.

**Step 3.** Using the screws supplied with the module, secure the module to the rear panel.

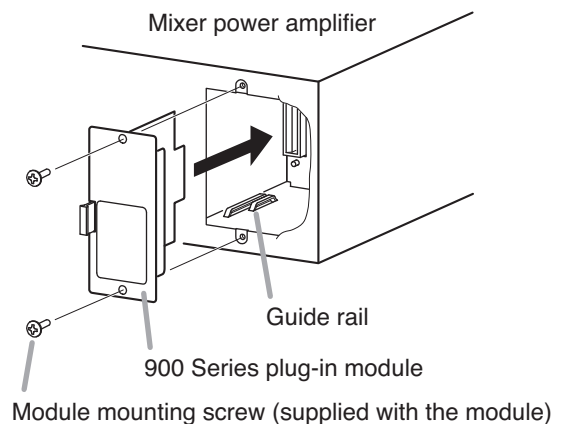

### 6.4. Output Connections

#### 6.4.1. Speaker connections

Each amplifier has 3 speaker outputs: 4 Ω, 25 V, and 70 V. Use only one of these outputs for connection. Class 2 wiring may be used.

**Note:** Impedances in the figures below represent total speaker load impedance.

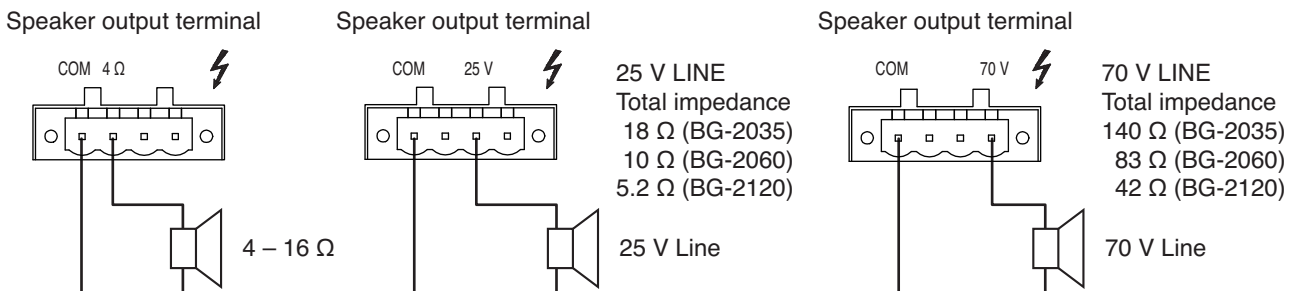

**WARNING**

The terminals marked with the symbol ⚡ are hazardous live. The external wiring to these terminals requires installation by an instructed person.

### 6.4.2. MOH output connection

The MOH output is 0 dB\*, 600 Ω, and balanced (transformer–isolated).

\* 0 dB = 1 V

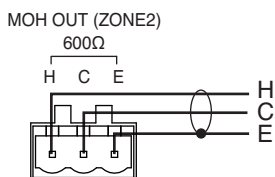

**Note**  
When connecting equipment with unbalanced input, short-circuit the “C” and “E” lines as shown at right.

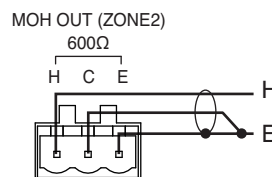

### 6.4.3. Line output connection

The Line output is 0 dB\*, 600 Ω, and unbalanced.

\* 0 dB = 1 V

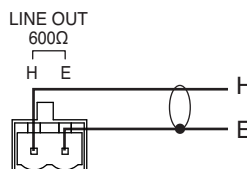

### 6.5. Manual Mute Terminal Connection

Closing between the manual mute (+) and (–) terminals causes the Mute Receive inputs to be muted (the inputs set to be muted).

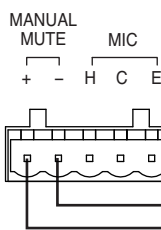

Short-circuit current: 1 mA or less  
Open voltage: 15 V or less

### 6.6. Remote Volume Control Connection

The mixed output level at post-input volume controls can be adjusted with an external remote volume control.

Note that individual input volume control positions limit the maximum output level adjustable with the remote volume control. Be sure to avoid turning down all input volume controls.

#### Notes

- Negative terminal should not be grounded. Never connect it to the unit's chassis nor other circuit ground.
- Only a volume control can be connected to this terminal.

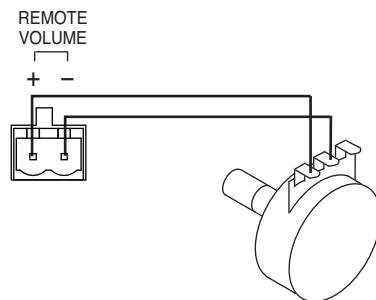

Volume control  
10 kΩ (linear-taper)

## 7. MUTING FUNCTION

Manual mute and Automatic mute are available for the muting function.

Manual mute is a function to mute the MIC, LINE 1/TEL, LINE 2, LINE 3 and/or MODULE input placed in Mute Receive mode when the manual mute terminal is short-circuited.

Automatic mute is an audio-signal activated muting function to automatically mute the MIC, LINE 1/TEL, LINE 2, LINE 3 and/or MODULE input placed in Mute Receive mode when audio signals enter the MIC, LINE 1/TEL, or MODULE input placed in Mute Send mode.

Neither manual mute nor Automatic mute works on the MOH output.

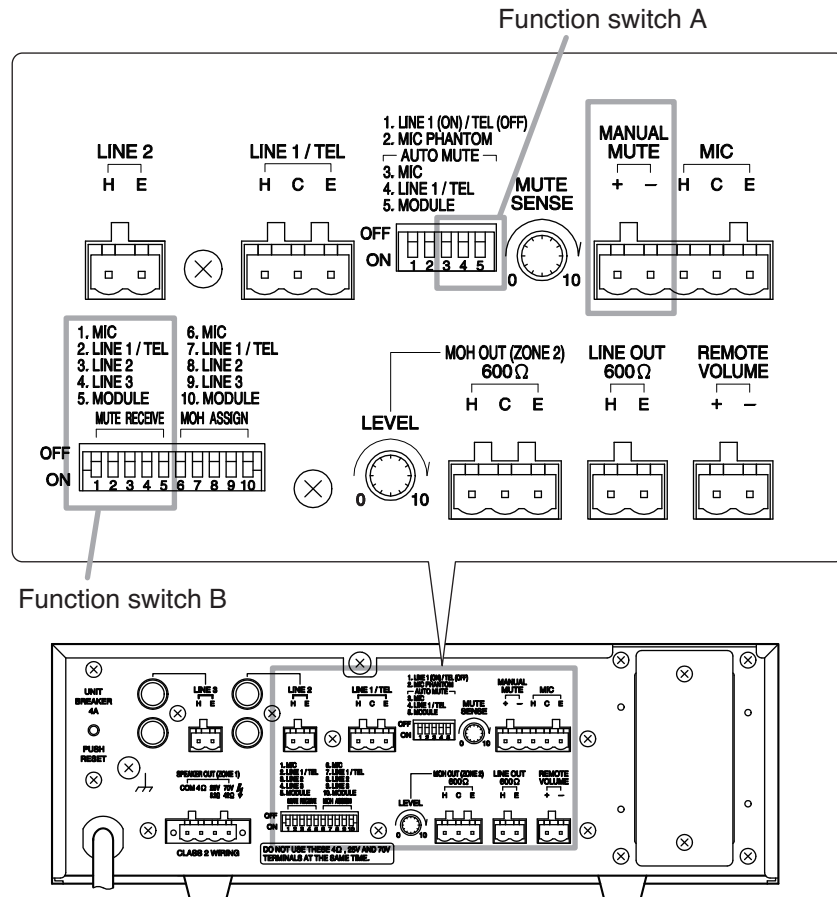

### 7.1. Manual Mute

**Step 1.** Set the inputs to be muted (Mute Receive inputs) with the Function switch B. Shift the DIP switches 1 to 5 to ON position to place each corresponding input in Mute Receive (muted) mode as follows.

- DIP switch 1: MIC input
- DIP switch 2: LINE 1/TEL input
- DIP switch 3: LINE 2 input
- DIP switch 4: LINE 3 input
- DIP switch 5: MODULE input

**Note**

Avoid assigning both Mute Receive and Mute Send functions to the same input.

**Step 2.** Close between the Manual mute (+) and (-) terminals. The Inputs set for Mute Receive in **Step 1** are muted.

**Step 3.** Open between these terminals. The signal being muted returns gradually to its original level in about 1 to 5 seconds.

**Note:** This function is active regardless of the Automatic mute ON/OFF setting using the Function switch A.

## 7.2. Automatic Mute

**Step 1.** Set the inputs to mute (Mute Send inputs) with the Function switch A.  
Shift the DIP switches 3 to 5 to ON position to place each corresponding input in Mute Send (muting) mode as follows.

- DIP switch 3: MIC input
- DIP switch 4: LINE 1/TEL input
- DIP switch 5: MODULE input

**Step 2.** Set the inputs to be muted (Mute Receive inputs) with the Function switch B.  
Shift the DIP switches 1 to 5 to ON position to place each corresponding input in Mute Receive (muted) mode as follows.

- DIP switch 1: MIC input
- DIP switch 2: LINE 1/TEL input
- DIP switch 3: LINE 2 input
- DIP switch 4: LINE 3 input
- DIP switch 5: MODULE input

**Note**

Avoid assigning both Mute Send and Mute Receive functions to the same input.

**Step 3.** Adjust the threshold level with the Mute Sensitivity Control at which the input placed in Mute Send mode in Step 1 will activate the muting function.

**Note**

The audio signal level to activate muting is independent of input volume settings. So, the Mute Receive input is muted if a signal enters the input placed in Mute Send mode in Step 1 even when the input volume is turned down. To avoid unwanted muting caused by unintentional inputs such as background noise and noise sound, it is recommended to cut the audio signal at the input equipment (such as a microphone with talk switch).

**Step 4.** The Mute Receive inputs (set in Step 2) are muted when audio signals enter the Mute Send inputs (set in Step 1).

**Step 5.** When the input signals are not present, the signal being muted returns gradually to its original level in about 1 to 5 seconds.

## 8. MOH OUTPUT ASSIGNMENT

Inputs selected by the Function switch B can be output to MOH output.  
Use the rear-mounted MOH volume control "LEVEL" to adjust the output level.

**Notes**

- Following are precautions on the MOH output.
- Each individual input level setting cannot be performed (the volume control does not work). Adjust the volume level at the input equipment as needed.
  - Bass and treble controls do not work.
  - Mute control does not work.
  - Remote volume control does not work.

**[MOH Output Setting]**

Set the input to be output to the MOH output using the Function switch B.  
The DIP Switch numbers correspond to the inputs as follows.

- DIP switch 6: MIC input
- DIP switch 7: LINE/TEL input
- DIP switch 8: LINE 2 input
- DIP switch 9: LINE 3 input
- DIP switch 10: MODULE input

- 1. MIC
- 2. LINE/TEL
- 3. LINE 2
- 4. LINE 3
- 5. MODULE
- 6. MIC
- 7. LINE/TEL
- 8. LINE 2
- 9. LINE 3
- 10. MODULE



## 9. 2-CHANNEL BROADCAST

Input signals set in Chapter 8 are output to the MOH output.

2-channel broadcast can be performed when the unit is used in conjunction with the optional BA-235 (35 W) or BA-260 (60 W).

(Example)

When MIC, LINE 1/TEL, LINE 2, LINE 3, and MODULE input signals are output to the Zone 1, and LINE 2 input signals to the Zone 2.

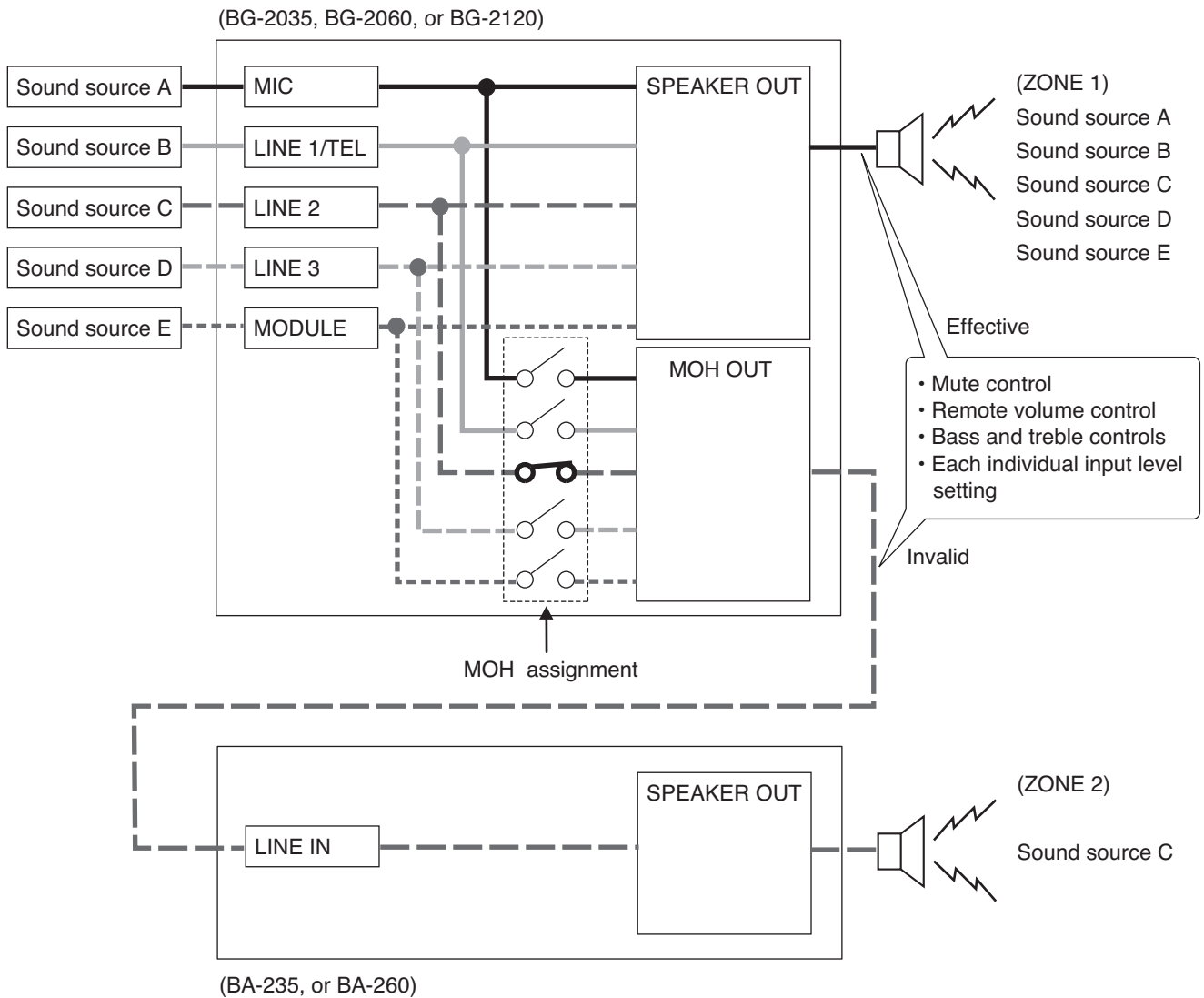

## 10. OPERATION

After completing all connections, turn on the power switch, and check to confirm that the power indicator lights.

### Note

When the heat sink temperature exceeds 105 °C (221 °F), the protection circuit begins to operate to disconnect the output from the circuit. The disconnected output is automatically restored as soon as the temperature returns to the normal operating range.

## 11. INSTALLATION PRECAUTIONS

### CAUTION

Keep the amplifier over 10 cm (3.94") away from objects that may obstruct air flow to prevent the unit's internal temperature rise.

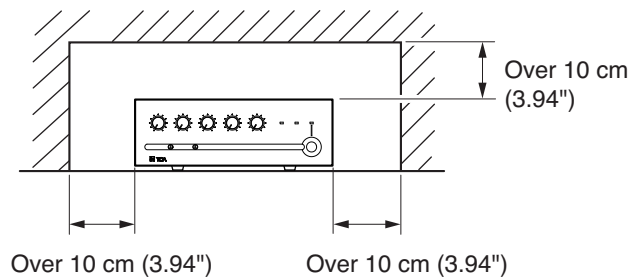

## 12. RACK MOUNTING BRACKET ATTACHMENT

To mount the amplifier in a standard 19" equipment rack, use the optional MB-1000 Rack Mounting Bracket. Attach the MB-1000 to the amplifier using the 4 supplied screws. When using other screws, ensure that each screw is shorter than 16 mm(0.63").

**Step 1.** Remove 4 screws on both sides of unit.  
The removed screws are not used.

**Step 2.** Attach the MB-1000 to the unit using 4 screws supplied with the MB-1000.

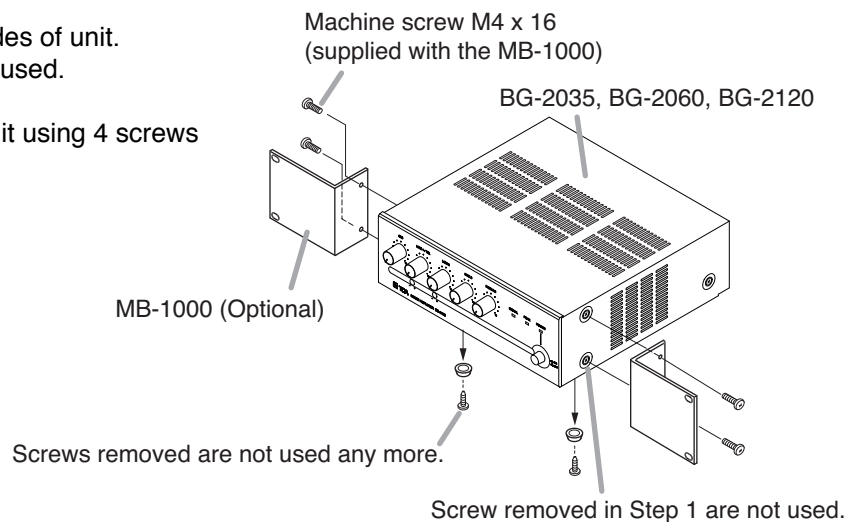

### Notes

- Remove 4 plastic feet on the bottom surface when mounting the unit in a rack.
- Rack mounting screws are not supplied with the unit. Use the screws that are appropriate for the rack.
- When mounting the unit in an equipment rack, the inside of the rack must be sufficiently ventilated. To achieve sufficient ventilation, also mount the optional PF-511 Perforated Panel (1U\*):
  - (1) at the top and the bottom of the rack, and
  - (2) above and below the unit.

\* 1U size = 44.5 mm or 1.75" (reference size)

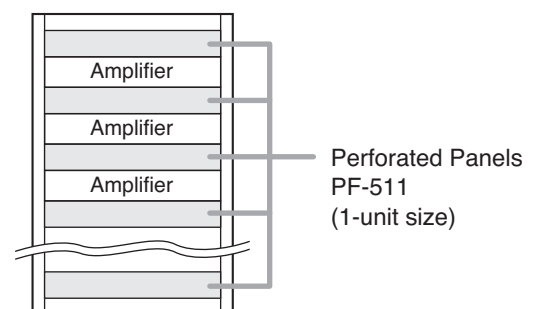

## 13. VOLUME SETTING

Output levels are adjustable with individual volume controls. For music play or announcement, adjust the corresponding volume control so that the signal indicator lights intermittently. Note that the sound quality is downgraded when the peak indicator remains lit.

## 14. VOLUME CONTROL COVER

To prevent the accidental change of the input volume control settings on the front panel, it is recommended to replace each control knob with the supplied YA-920 Volume Control Cover. Follow the procedure below for its replacement.

**Step 1.** Remove the control knob.

**Step 2.** Adjust the Input volume control (without knob) to an appropriate level.

**Step 3.** Attach the YA-920 onto the control.

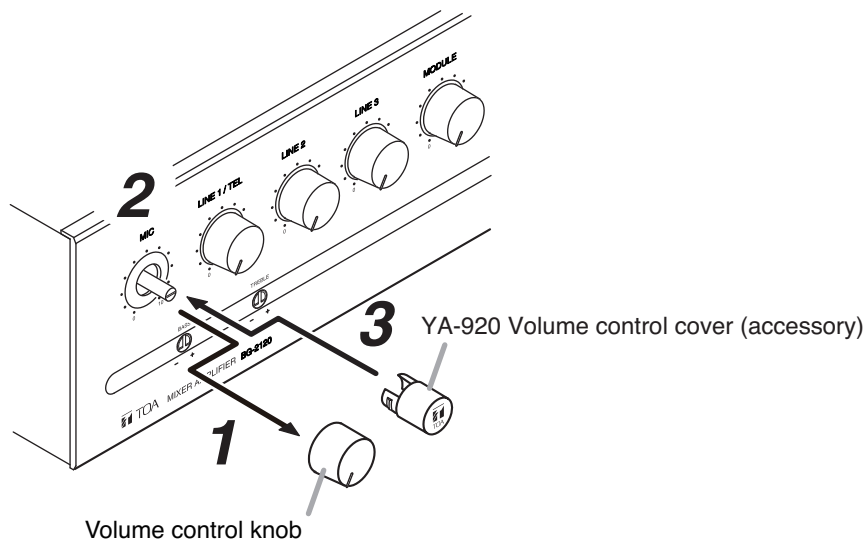



# 15. BLOCK DIAGRAM

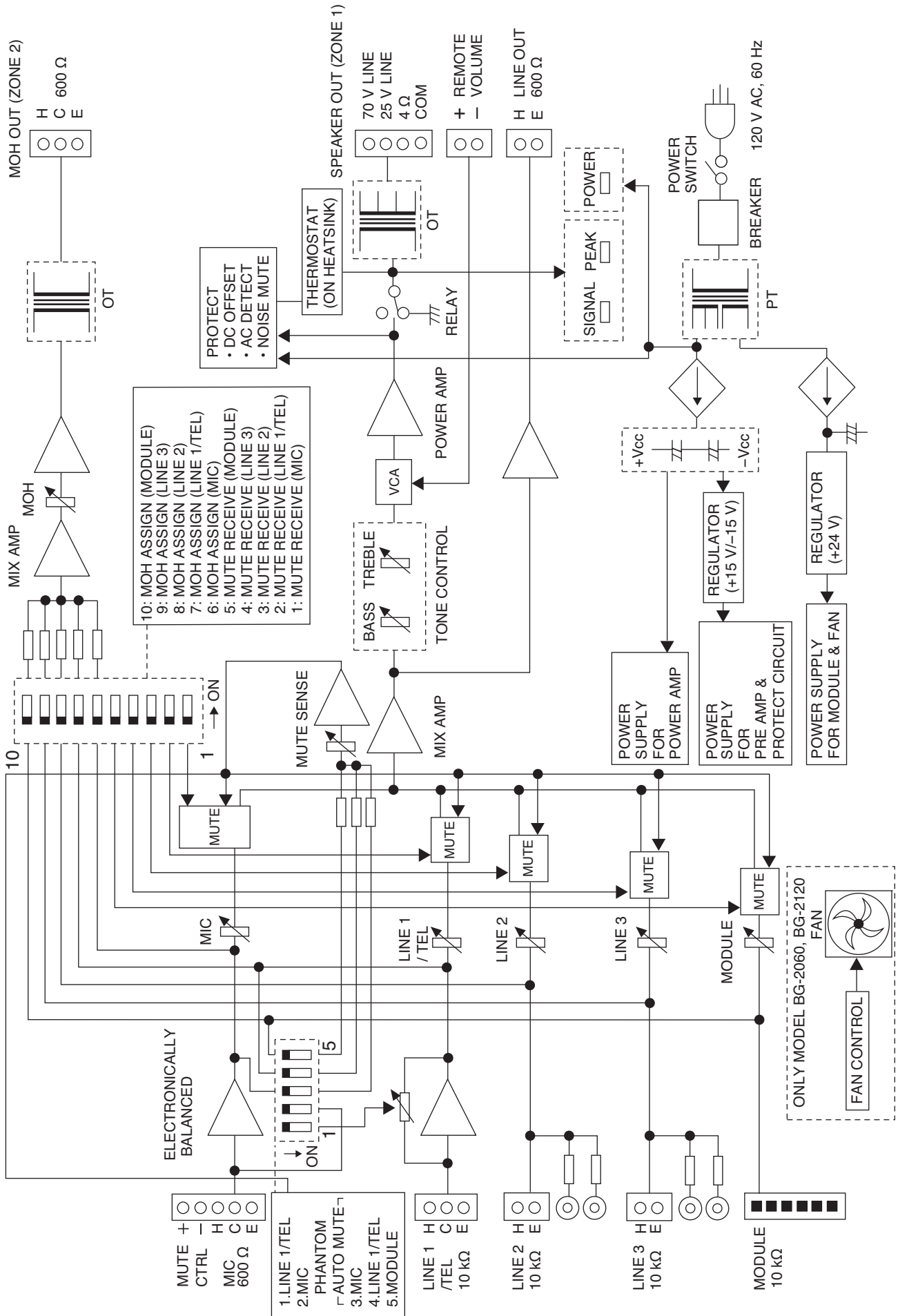

# 16. DIMENSIONAL DIAGRAM

Unit: mm (in)

[Rear]

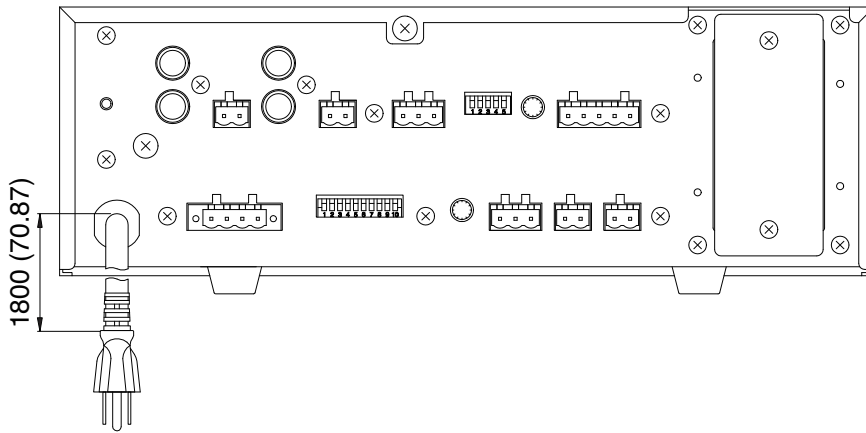

[Front]

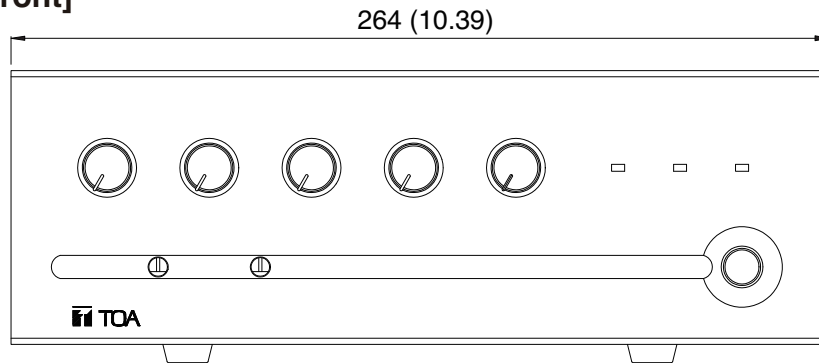

[Side]

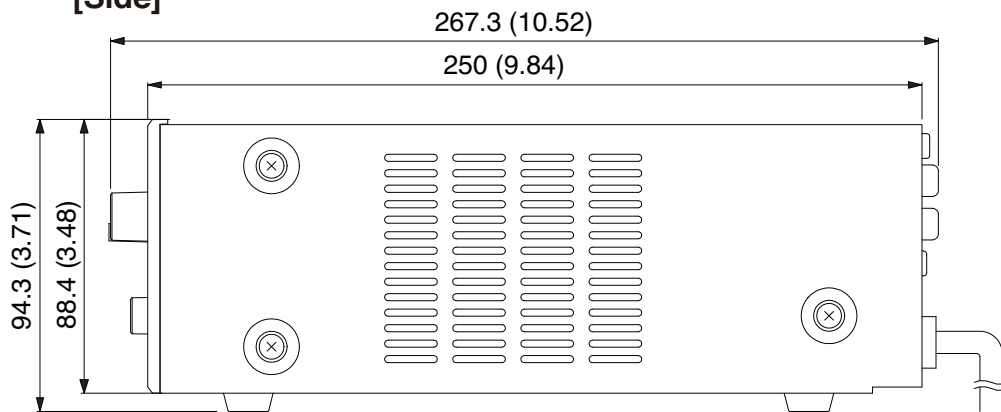

## 17. SPECIFICATIONS

Model No.	BG-2035	BG-2060	BG-2120	
Power Source	120 V AC, 60 Hz			
Rated Output	35 W	60 W	120 W	
Power Consumption				
Rated Output	94 W	163 W	265 W	
Based on cULus standards	50 W	80 W	120 W	
Frequency Response	50 Hz – 20 kHz			
Total Harmonic Distortion	0.5% or less, at 1 kHz, rated output			
Input	Microphone, Line 1/TEL (Selectable), Line 2, Line 3, Module			
Input Sensitivity/	Microphone: –60 dB*, 600 Ω, electronically balanced, removable Impedance terminal block Line 1/TEL: –10 dB*/–20 dB*, 10 kΩ, electronically balanced, removable terminal block Line 2: –10 dB*, 10 kΩ, unbalanced, removable terminal block and RCA jacks Line 3: –10 dB*, 10 kΩ, unbalanced, removable terminal block and RCA jacks Module			
Output	Speaker Output	4 Ω, 25 V (18 Ω), 70 V (140 Ω)	4 Ω, 25 V (10 Ω), 70 V (83 Ω)	4 Ω, 25 V (5.2 Ω), 70 V (42 Ω)
		Balanced, removable terminal block		
	MOH Output	0 dB*, 600 Ω, balanced, removable terminal block		
	Line Output	0 dB*, 600 Ω, unbalanced, removable terminal block		
Output Regulation (1 kHz)	Under 2 dB, no load to full load			
S/N Ratio	Microphone: Over 60 dB Line 1/TEL: Over 75 dB Line 2: Over 75 dB Line 3: Over 75 dB Module: Over 75 dB (Band Pass: 20 Hz – 20 kHz, Tone Controls: Centered)			
Tone Control	Bass: ±10 dB at 100 Hz, Treble: ±10 dB at 10 kHz			
Control	Microphone gain control, Line 1/TEL gain control, Line 2 gain control, Line 3 gain control, Module gain control, Bass tone control, Treble tone control MOH out gain control Mute control (Manual mute) Remote volume control Mute sensitivity control Line 1/TEL selector switch Phantom power switch (Microphone) Automatic mute switch (Microphone, Line 1/TEL, Module) Mute receive switch (Microphone, Line 1/TEL, Line 2, Line 3, Module) MOH assign switch (Microphone, Line 1/TEL, Line 2, Line 3, Module) Power ON/OFF switch			
Indicator	Power LED, Signal level LED, Peak LED			
Other Feature	Automatic electronic drive limiter			
Operating Temperature	0 to 40 °C (32 to 104 °F)			
Operating Humidity	35% – 80% RH (no condensation)			
Finish	Panel: ABS resin, black Case: Steel plate, black, paint			
Dimensions	264 (w) x 94.3 (h) x 267.3 (d) mm (10.39" x 3.71" x 10.52")			
Weight	5.3 kg (11.68 lb)	5.3 kg (11.68 lb)	6.0 kg (13.23 lb)	

\* 0 dB = 1 V

**Note:** The design and specifications are subject to change without notice for improvement.

• **Accessories**

YA-920 Volume control cover ..... 5  
Removable terminal plug (2P) ..... 4  
Removable terminal plug (3P) ..... 2

Removable terminal plug (4P) ..... 1  
Removable terminal plug (5P) ..... 1

• **Optional Product**

Rack mounting bracket: MB-1000